

Safe-D U-clips can be fitted direct-to-surface, or in non-metallic trunking systems. All can be secured to substrates by shot-fired nails or screw-fixings.

After cables are inserted, tabs can be folded inwardly to safely secure the cables. They are produced from a specified steel with >1200°C melting point.

The combination of the pliable gauge steel & rounded corner features makes Safe-D U-Clips quick & easy to install. Three sizes are available to fit trunkings from 25mm width up to 50mm wide bases, or direct-to-surface.

- Certified for 2 hours at 970°C
- Thumb friendly, easy fold side-tabs
- Ideal for ceiling voids, or popular PVC trunking
- Rounded edges for easy handling
- Supplied in bags of 25 pcs

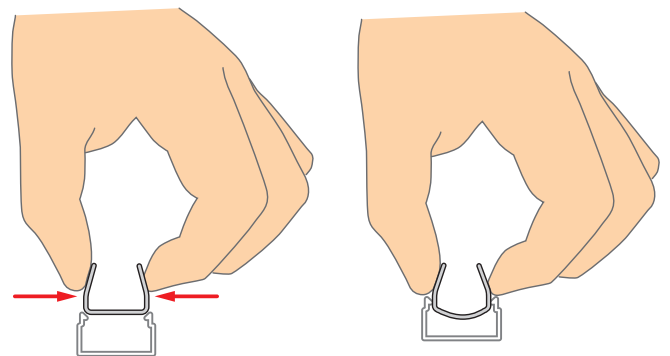

When inserting U-Clip 30 in 25x16mm trunkings, gently squeezing the upright tabs causes the base to compress for tight fitment in Size 2 trunkings.

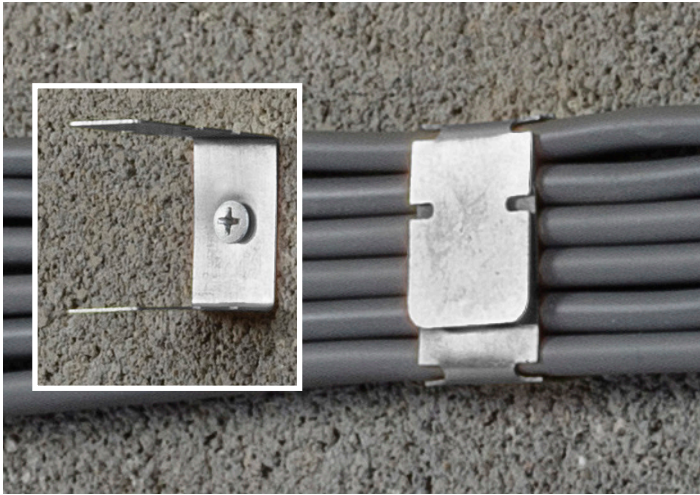
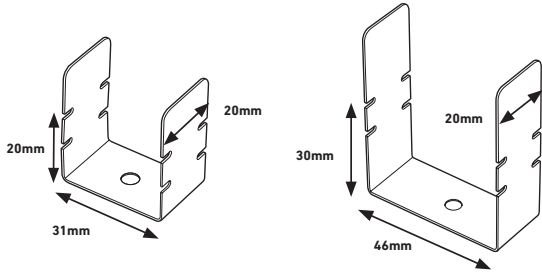

Safe-D U-Clip 40 is ideal for fitment in 38mm or 40mm non-metallic trunking bases, or to provide a first-fix solution for securing cables direct to surfaces.

Safe-D U-Clip 50 Clips are popular for fitment in 50mm non-metallic trunking bases, or to provide a first-fix solution for securing cables direct to surfaces.

Installers should use a fire-rated fixing, and then simply fold-over tabs to secure cables.

1st fix clips, then 2nd fix cables!

- Certified for 2 hours at 970°C
- Thumb friendly, easy fold side-tabs
- Ideal for ceiling voids, or popular PVC trunking
- Rounded edges for easy handling
- Supplied in bags of 25 pcs



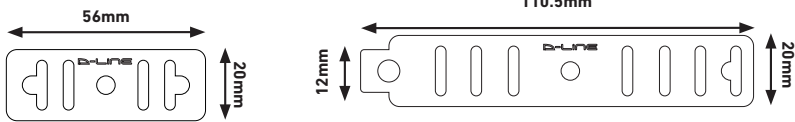

Safe-D F-Clip 30 & 40s are fire-rated flexible cable clips that are supplied in flat form, and can be quickly folded to secure cable installations.

- Supplied flat...
 - Space efficient and pocket friendly
 - Easier handling - to save installation time
 - Easy folding to consider space and cable volume
 - Perfect for shot fired fixings
- >1200°C melting point
- Slots enable use as cable tie base
- 3x fixing holes for versatility
- Thumb friendly, rounded corners, 20mm wide, and pliable for easy installation
- Fit direct to surface, or in PVC trunkings
- Easy to later add or remove cable(s)
- Uniquely versatile - for shaping as required



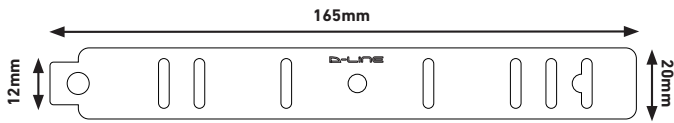

Safe-D F-Clip 30 & 40s are fire-rated flexible cable clips that are supplied in flat form, and can be quickly folded to secure cable installations.

- Supplied flat...
 - Space efficient and pocket friendly
 - Easier handling - to save installation time
 - Easy folding to consider space and cable volume
 - Perfect for shot fired fixings
- >1200°C melting point
- Slots enable use as cable tie base
- 3x fixing holes for versatility
- Thumb friendly, rounded corners, 20mm wide, and pliable for easy installation
- Fit direct to surface, or in PVC trunkings
- Easy to later add or remove cable(s)
- Uniquely versatile - for shaping as required



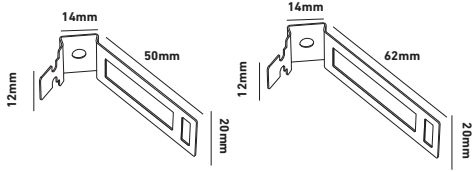
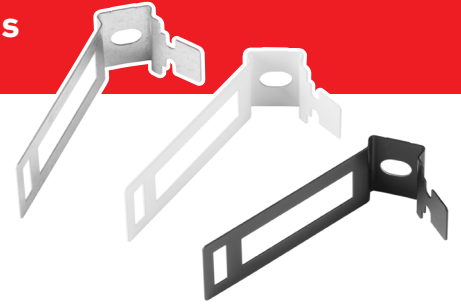

Provides a 3mm stand off from the surface



Simply wrap around the conduit, perfect for tight spaces



Secure conduit with locking tab



Centralised base fixing, gives a neat appearance to installation

Safe-D Conduit Saddles combine fire performance, quickest fix, and a modern look, to secure cables in 20mm & 25mm outer diameter PVC and galvanised conduit installations... & 20mm or 25mm o/d cables and pipes.

1 piece for only 1 fixing!

- Modern, stylish appearance
- Ideal for tight spaces
- Non-corrosive finish
- Unique single piece fixing, only 1x screw required - labour-saving design
- Available in white, black or galvanised finish
- Adjustable slot in base for fixings
- Supplied in bags of 5 pcs

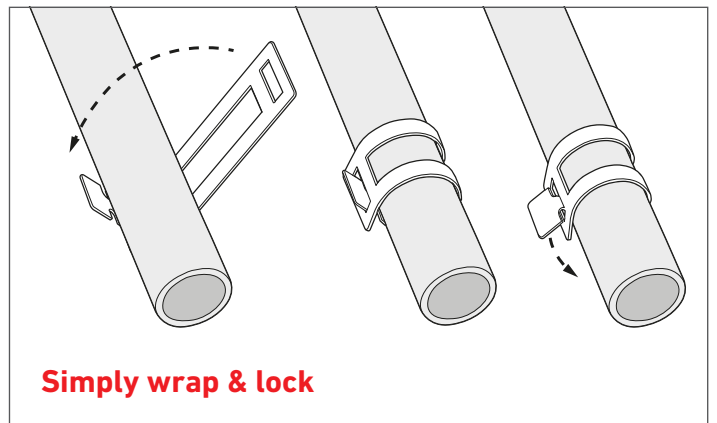

Simply wrap & lock

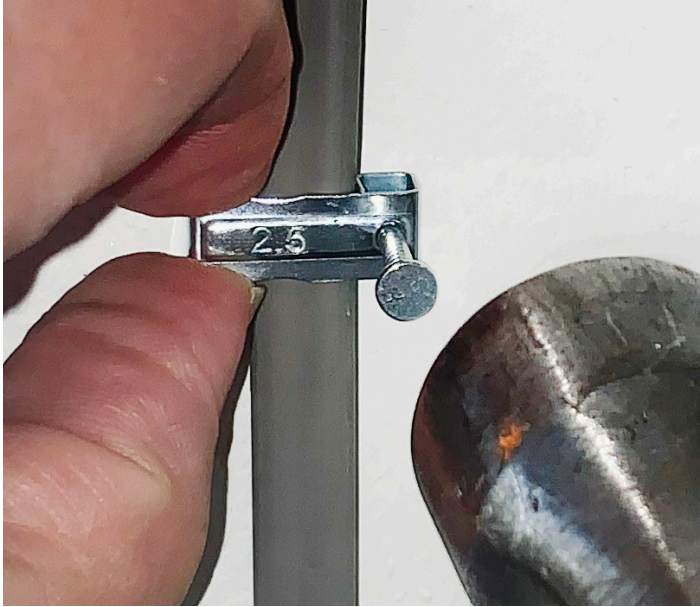

Safe-D T&E Grip Clips are user-friendly by a symmetrical design that makes it easy to hold the clip over T&E cable during installation... keeping finger and thumb away from hammer.

Grip Clips include flat-head nails with 2.5mm diameter shafts that enable effective knock-in to mortar and wood; compared to alternative designs with thinner nails, the 2.5mm shaft minimises the risk of a nail bending or buckling in hard substrates.

- Produced from steel, fire-rated to 1200C+
- Flat-head nail sits tight when knocked-in
- 2.5mm diameter nail body, suitable for harder substrates
- User-friendly design for easy positioning - keeping finger & thumb away from hammer
- 3x sizes for popular T&E clips (1.5, 2.5 & 6.0mm)²
- Raised strip on clip-head prevents cable bruising if mis-hit!
- All nails have 2.5mm body dia, 5.5mm head dia & 25mm length
- Supplied in bags of 20 pcs



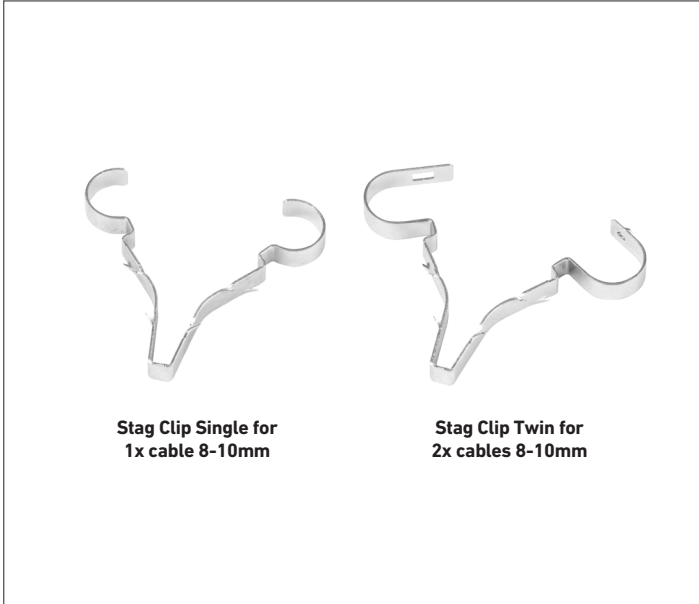

Drill pilot hole & select appropriate size of Stag Clip



Rest Stag Clip in the pilot hole ready to accept cable(s)



Insert cable(s) before squeezing the smooth head



Push home to secure the Stag Clip and cable(s)

Safe-D Stag Clips can be first-fixed with their lower barbs gripping in pilot-holes, ready for second-fix cabling works.

- >1200°C melting point
- Can be 1st fix rested in pilot hole, before 2nd fix inserting cable(s)
- No screw required, simply push smooth head in pilot hole, 5.5mm or 6mm x 30mm deep*
- Head sections overlap for secure cable fitment. 2x cable versions lock together when overlapped
- Ideal for FP & MICC cables, T&E and flexes
- Supplied in bags of 20 pcs

