

D-Line[®]
Trade

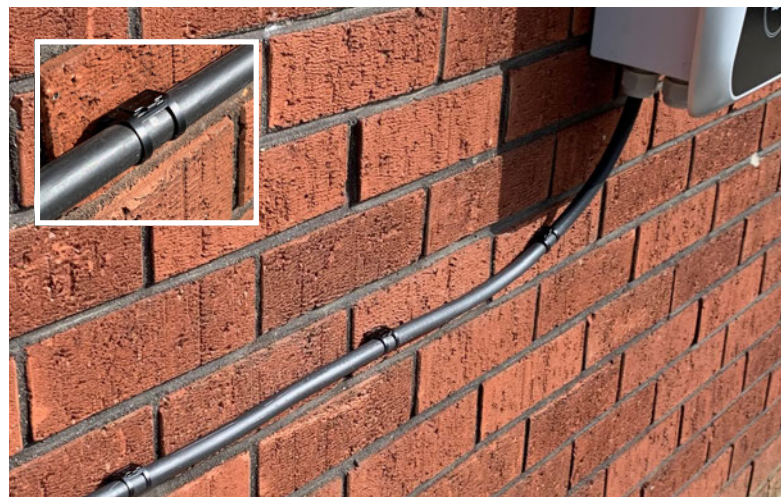

Innovative Cable Management

Where time, safety and appearance matter

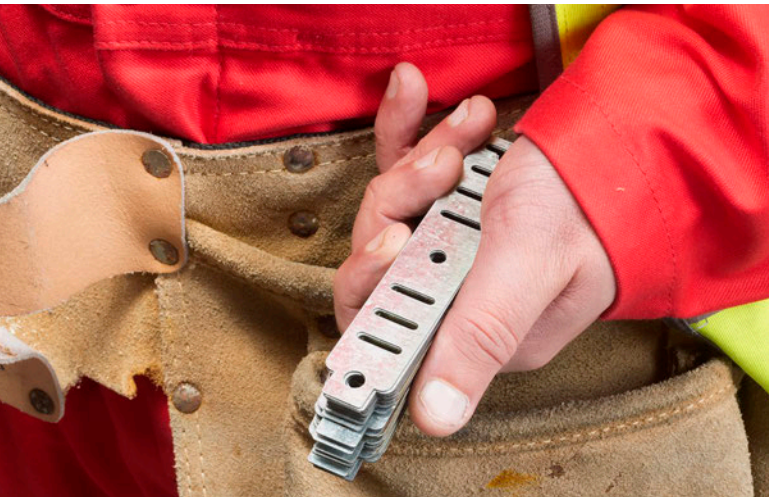

Trunking overview	
About D-Line	pg 3
A quick guide	pg 4
Case study	pg 5
Micro trunkings	pg 6
20x10mm ½-round trunking	pg 7
30x15mm ½-round trunking	pg 8
50x25mm ½-round trunking	pg 9
U-Clip 30	pg 10
U-Clip 40 & 50	pg 11
F-Clip folding options	pg 12
F-Clip 30 & 40	pg 13
F-Clip 50	pg 14
Conduit Saddles	pg 15
Stag Clips	pg 16
T&E Grip Clips	pg 17
Cable Safety Overview	pg 18
Floor Cable Protectors	pg 19
Cable Zipper	pg 20
Socket Enclosures & Split Cable Tube	pg 21
Spiral Wrap & Cable Band	pg 22

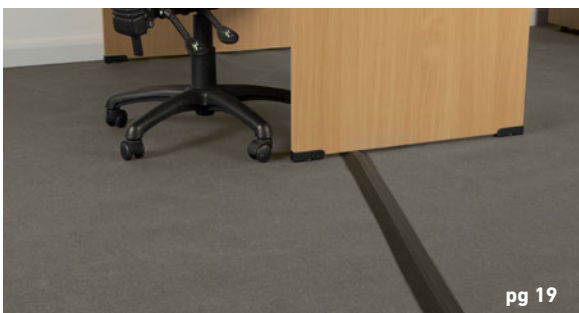
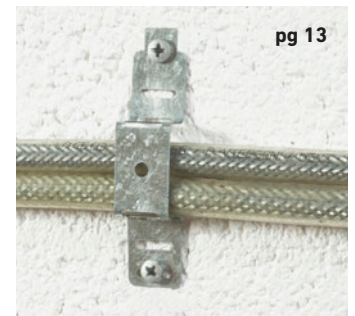
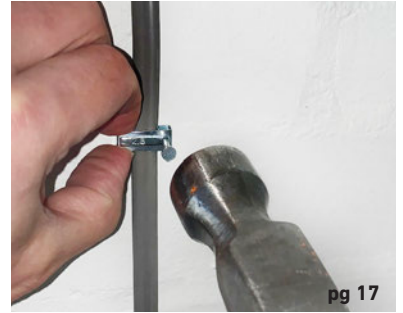



D-Line is a UK company, based in Newcastle upon Tyne, with 26x patents, 75x registered designs & a global reputation for innovative cable management products.

For specifiers & installers we offer non-metallic trunking systems, fire-rated cable supports, floor cable protectors, & alternative cable organisers. This Guide highlights D-Line's core products where the labour-saving or functionality make best choices **'for use where time, safety & appearance matter'**.

Full details of other innovative D-Line products are available in our specialist brochures, and website, or please contact D-Line sales team who will be happy to assist.

Most D-Line products are manufactured in the UK, fully tested and certified to highest quality requirements. All are made to most exacting standards.

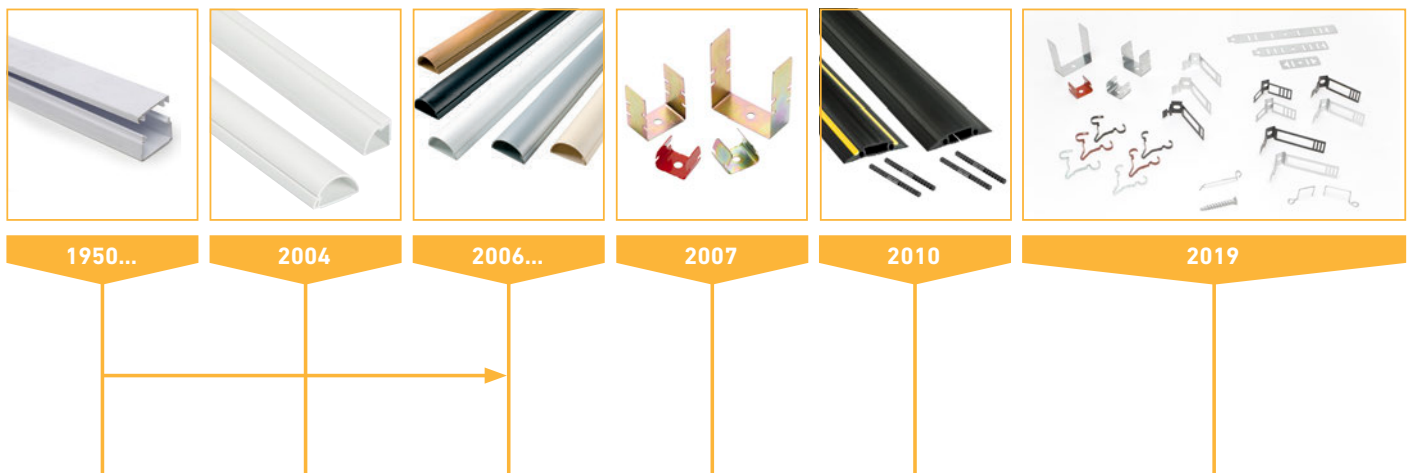

To hide cables either channelling walls or blocky trunking were only options available

D-Line patent ½ and ¼ round one-piece Trunking systems

D-Line Trunkings launched for use **'where time, safety and appearance matter'**

D-Line create range of **Safe-D** Fire Rated Clips, for trunking or direct-to-surface

D-Line launch Linkable Floor Cable Protectors

Now 35x innovative Fire-Rated Cable Supports



D-Line Trunking - A Quick Guide

	<p>Designer shapes and colours</p> <p>Subtle appearance with no sharp edges; to blend with decor Alternative cable capacities satisfy popular demands Colour options to provide a striking feature!</p> <p>Available as (width x height) 16x8mm, 20x10mm, 30x15mm & 50x25mm</p> <p>Impact-resistant & easy to clean</p>
 	<p>Film covered, PVC lengths</p> <p>Keeps lengths pristine before installation PVC lengths, UV stabilized Strong, but easy to cut Safety tested & certified Easy to cut if required</p>
 	<p>Self-adhesive</p> <p>Simply peel & stick Can be drilled also</p>
 	<p>Patented single-piece design</p> <p>For quick & easy handling Tensioned hinge lid retains cables during installation Hinge is not overly stiff or slack, can be opened/closed millions of times - easy to later add or remove cables Lids will never peel or detach - maintenance friendly Fully safety tested and certified to BS EN 50085-1:2005</p>
   <p>All Clip-Over accessories have grip tabs. The grip tab simply clips over the top of the length</p>	<p>Accessories</p> <p>Push-on design with rear grip tabs hold accessories securely Smooth-fit connectors & end caps Range of adaptors to join with socket blocks and other interfaces</p>
 	<p>Easy-clean profile</p> <p>No flat dust-ledges Only one groove, for infection control Easily wipes clean</p> 
 	<p>Paintable</p> <p>Can blend with any decor</p>

- D-Line offer inexpensive and practical alternatives to *either* channelling walls *or* traditional mini-trunking
- In occupied in-use buildings, D-Line saves significant time, hassle & cost!
- D-Line installations complement the interior designs of modern spaces, in ways that are appreciated by all stakeholders



When 20,000 hotel rooms needed to hide cables for new heating controllers, D-Line Mini Trunking proved the perfect choice... using D-Line saved a small fortune compared to the cost of channelling the walls, then needing to co-ordinate works to re-plaster and re-decorate.

Aside the noise and disruption, trying to recess the cabling would have put rooms out-of-service. However traditional trunking did not look suitable for a hotel chain with a reputation for comfort and style.

Cables from wall mounted heaters to wall mounted controllers were concealed in D-Line Mini Trunking which blended with the skirting, and, when necessary, up-and-around bedheads.

A cut-length rose up to the heater via a Clip-Over Equal Tee, while Clip-Over Internal Bends made internal corner connections quick and easy. The Flat Bend required was a Smooth-Fit version, as the secure internal tabs were favoured to eliminate future maintenance concerns, given that this part was most likely to be bumped by guests' baggage.

The ½ round shape of the length rising up to the wall-mounted controller was preferred also for its impact resistance, the lack of sharp edge a distinct benefit (compared to traditional sharp edge trunking).

The D-Line Cutting Tool was used throughout, saving time and leaving no PVC dust residue. The self-adhesive tape was used to attach the lengths to the walls, with a screw-fixing and plug then inserted 750mm from each end.

The result was 20,000 installations using 200km - all easy to fit, quick to install and blending with decor.

Further details on request.

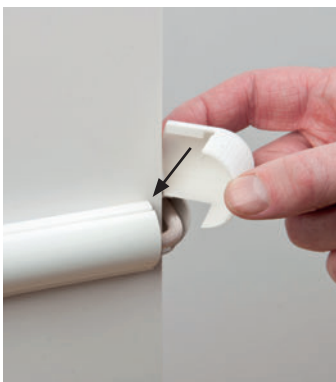

Unique Clip-Over Accessories

Saves Channelling Walls

Quick and Easy to Fit

Micro Trunkings

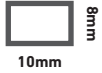

Square/Rectangular Trunking - 10mm x 8mm

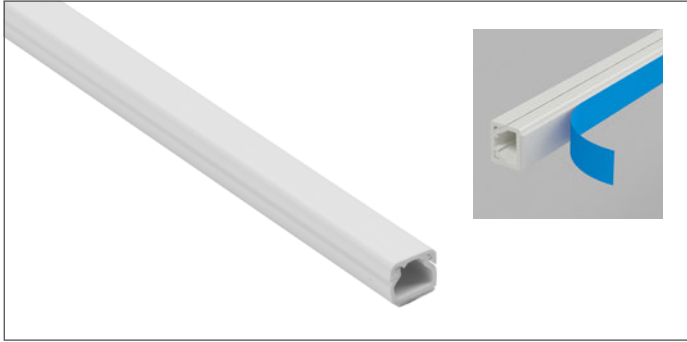

D-Line 10x8mm is an ultra-slim profile for the smallest of cables, & suitable for tight spaces.

Ideal for alarm cables, bellwire, telephone & speaker cables.

- Rectangular profile, 10x8mm (WxH)
- Clip-on lid
- Corners can be mitre-cut
- Self-adhesive
- Paintable

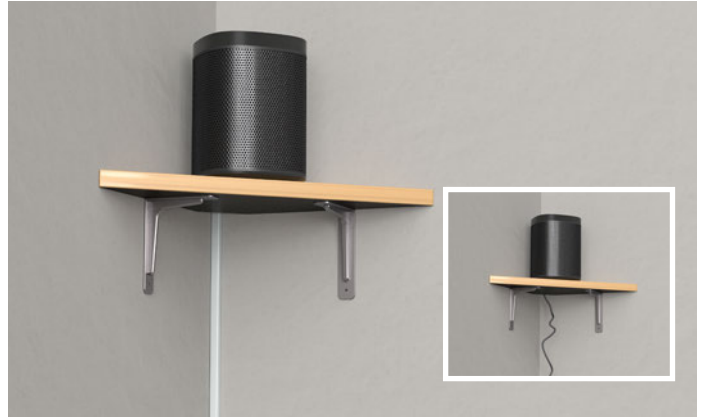

Code	Description	Colour
DLFSA108W/2	(L) 2m x (W) 10mm x (H) 8mm	White



Micro Trunking - 16mm x 8mm



To hide speaker cable, bell wires, telephone and alarm cable, Micro Trunking offers a discreet solution.

Available in a choice of colours and with a range of Smooth-Fit accessories; that give a flush appearance.

- Micro ½ round profile, only 16x8mm (WxH)
- Patented hinge & click-lock lid
- Smooth-Fit accessories available for perfect finish
- Self-adhesive, or can be drilled & screw-fixed



Code	Description	Colour
D21608WSA	(L) 2m x (W) 16mm x (H) 8mm	White



Black & Oak Effect available on request.



Micro+ Trunking - 20mm x 10mm



D-Line 20x10mm Micro+ profile gives a neat solution for single cables, while offering additional internal capacity that can be useful around corners.

Complementary Clip-Over bends and tees can provide a perfect finish and are quick & easy to install.

Ideal for flexible cables (up to 8mm outer diameter), also fibre-optic, satellite/aerial and broadband cable installations.

- Discreet and stylish appearance; only 20x10mm (WxH)
- Patented hinge & click-lock lid
- Clip-Over accessories available for perfect finish
- Self-adhesive, or can be drilled & screw-fixed



Code	Description	Colour
D22010WSA	(L) 2m x (W) 20mm x (H) 10mm	White

Full range of accessories available



Black available on request.

Mini Trunking - 30mm x 15mm

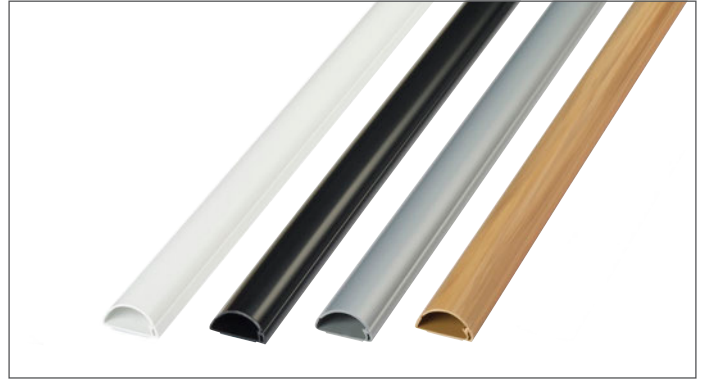
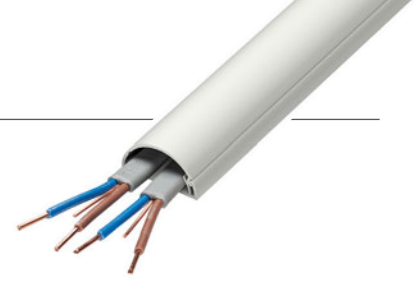
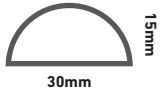

D-Line 30x15mm Mini Trunking offers a subtle appearance to make surface cable installations look attractive!

The ½ round shape can blend to resemble the natural top-section of skirting boards, while offering a modern solution for vertical cable drops and runs across ceilings.

Available in a variety of colours that can blend with surrounds or create a striking visual feature, this versatile profile is popular for 2x 2.5mm T&E, 2x 1.5mm 2c FP cables, 2x broadband cable and 4x Cat-5 combinations.

- Unique stylish 'D-Line' appearance
- Self-adhesive, or can be drilled & screw-fixed
- Clip-Over & Smooth-Fit accessories for perfect finish
- Can contain Safe-D U-Clip 30 to secure cables

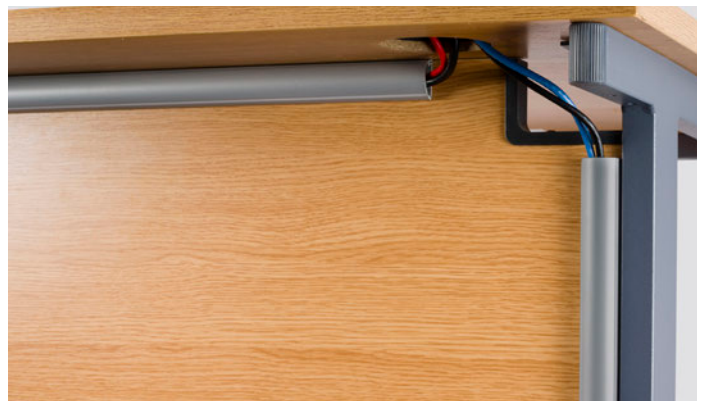

Code	Description	Colour
D23015WSA	(L) 2m x (W) 30mm x (H) 15mm	White



Black, Aluminium Effect & Oak Effect available on request.

Full range of accessories available

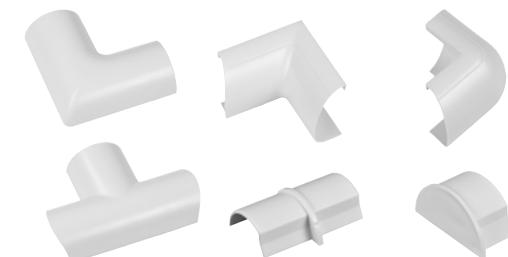

With U-Clip 30

Maxi Trunking - 50mm x 25mm

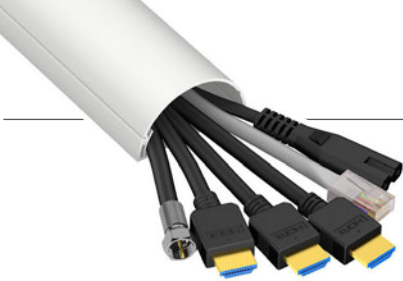
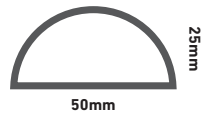

D-Line 50x25mm Maxi is a versatile trunking, providing capacity for several cables.

The size, capacity and range of colours makes this profile a market-leading solution that is ideal for many AV, electrical and datacoms projects.

- Unique stylish 'D-Line' appearance
- Saves channelling walls
- Self-adhesive, or can be drilled & screw-fixed (as recommended for best practice)

Code	Description	Colour
1D5025W/EH	(L) 1m x (W) 50mm x (H) 25mm	White



Black & Aluminium Effect available on request.

½ round Clip-Over Accessories - for 20x10mm & 30x15mm



Internal Bend
Join lengths around 90 degree inside corners



External Bend
Join lengths around 90 degree outside corners



Flat Bend
Change direction by 90 degrees on flat surfaces

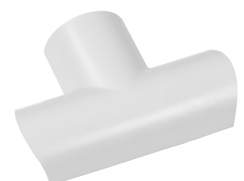

Equal Tee
Use to join 3 lengths of same profile

Safe-D U-Clip 30 - Fully tested & certified

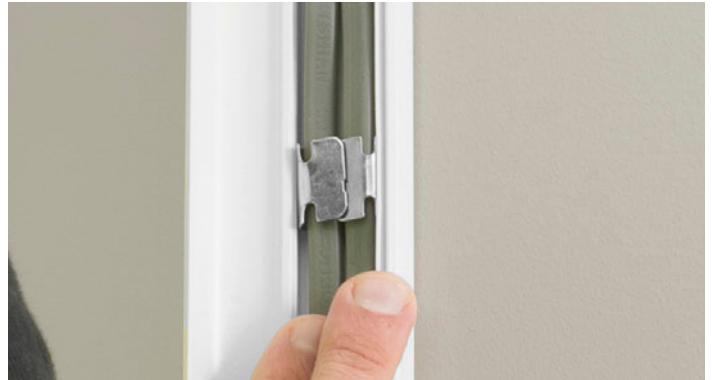
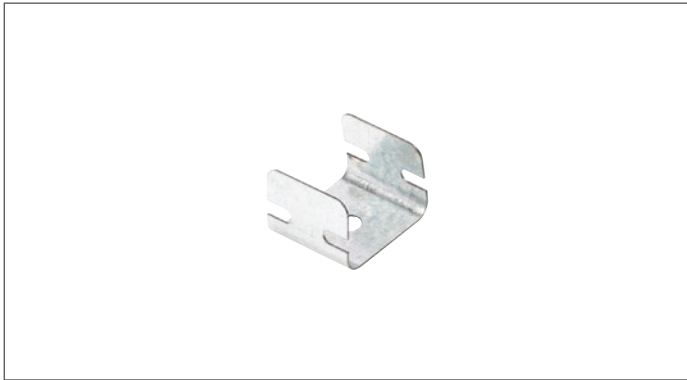
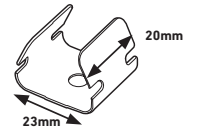

Safe-D 30



Suitable for direct to surface fitting

1st fix clips, then 2nd fix cables!

- Certified for 2 hours at 970°C
- Thumb friendly, easy fold side-tabs
- Ideal for ceiling voids, or popular PVC trunking
- Rounded edges for easy handling
- Red U-Clips are popular for fixing direct to surface
- Supplied in bags of 25 pcs

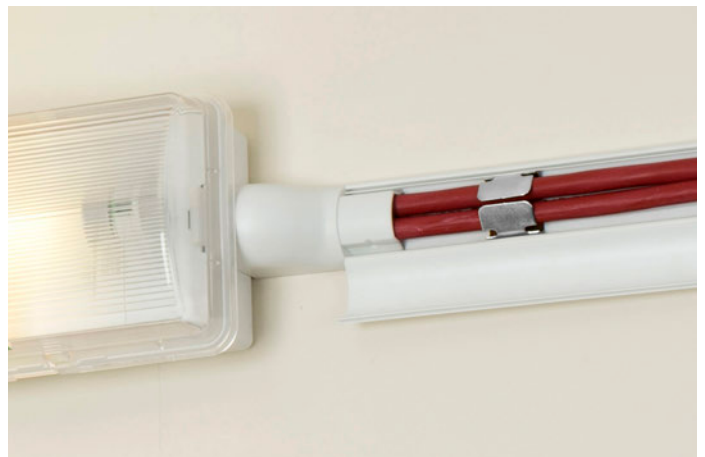

Code	Description
SAFE-D30/25	(L) 20mm x (W) 23mm x (H) 8mm (folded) 5.7mm diameter pre-drilled hole in base

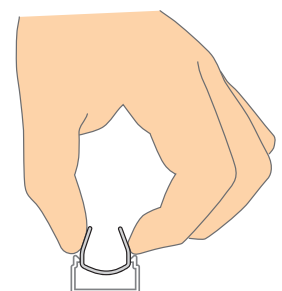
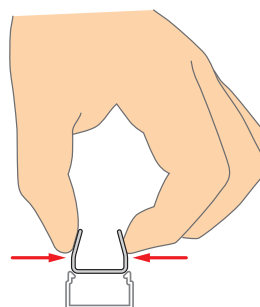

When inserting U-Clip 30 in 25x16mm trunkings, gently squeezing the upright tabs causes the base to compress for tight fitment in Size 2 trunkings.

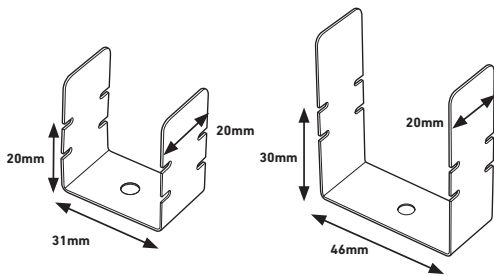

Safe-D U-Clip 40 & 50 - For 38mm - 50mm+ Trunkings

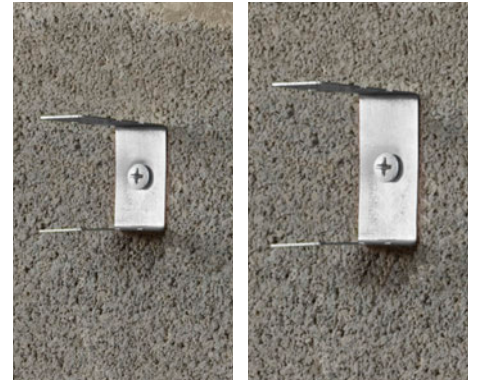

Safe-D U-Clip 40 is ideal for fitment in 38mm or 40mm non-metallic trunking bases, or to provide a first-fix solution for securing cables direct to surfaces.

Safe-D U-Clip 50 Clips are popular for fitment in 50mm non-metallic trunking bases, or to provide a first-fix solution for securing cables direct to surfaces.

1st fix clips, then 2nd fix cables!

- Certified for 2 hours at 970°C
- Thumb friendly, easy fold side-tabs
- Ideal for ceiling voids, or popular PVC trunking
- Rounded edges for easy handling
- Supplied in bags of 25 pcs

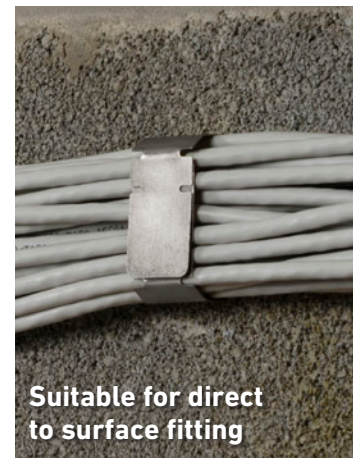
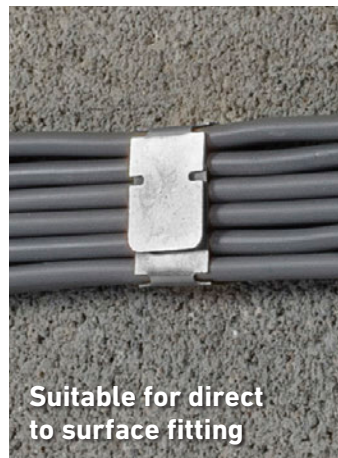

Code	Description
SAFE-D40/25	(L) 20mm x (W) 31mm x (H) 20mm (folded) 5.7mm diameter pre-drilled hole in base
SAFE-D50/25	(L) 20mm x (W) 46mm x (H) 30mm (folded) 5.7mm diameter pre-drilled hole in base



Safe-D F-Clips - Flat-form, flexible and foldable, fire-rated cable supports

F-Clips offer unique versatility for multiple uses...

Safe-D F-Clip 30

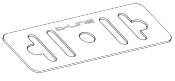

Safe-D F-Clip 40

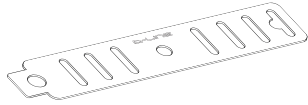

Safe-D F-Clip 50

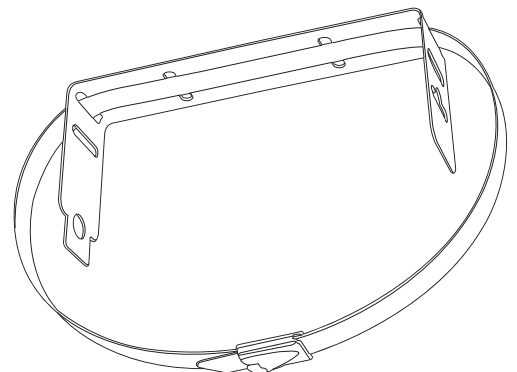
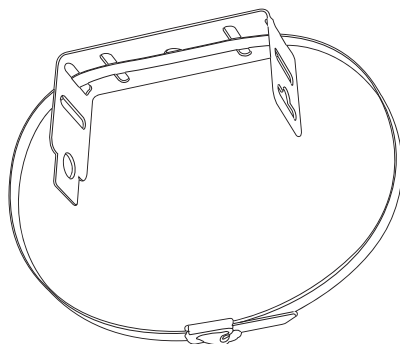
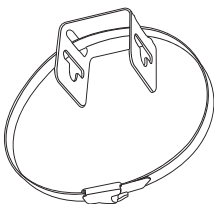
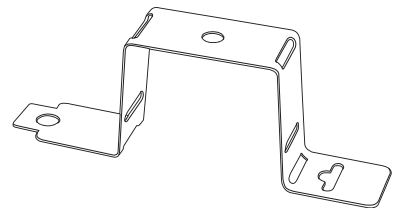
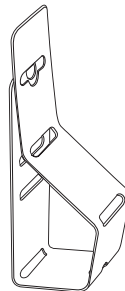
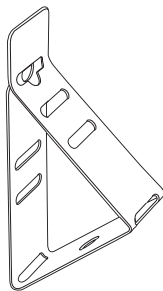
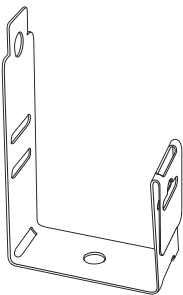
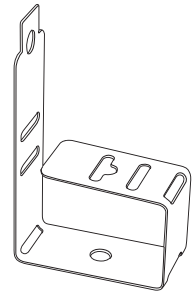
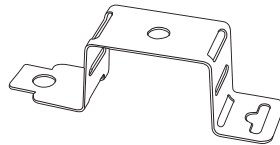
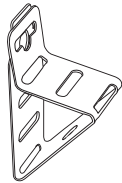
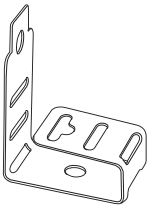
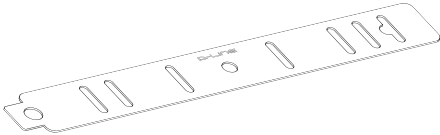

Safe-D F-Clip 30 & 40 - Flex, Fit, Fold

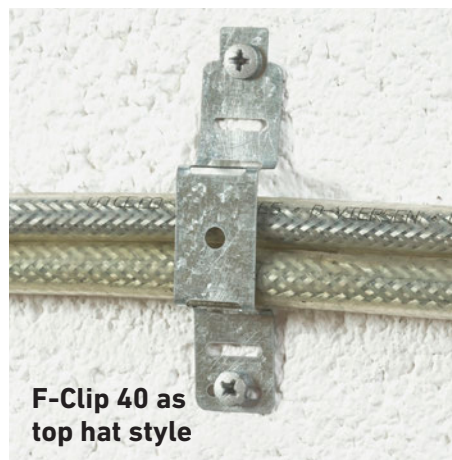
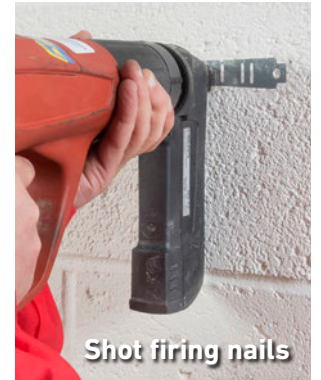
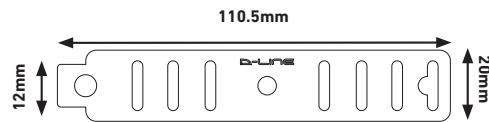
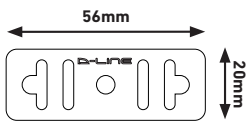

Safe-D F-Clip 30 is a fire-rated flexible cable clip that is supplied in flat form, and can be quickly folded to secure cable installations.

- Supplied flat...
 - Space efficient and pocket friendly
 - Easier handling - to save installation time
 - Easy folding to consider space and cable volume
 - Perfect for shot fired fixings
- >1200°C melting point
- Slots enable use as cable tie base
- 3x fixing holes for versatility
- Thumb friendly, rounded corners, 20mm wide, and pliable for easy installation
- Fit direct to surface, or in PVC trunkings
- Easy to later add or remove cable(s)
- Uniquely versatile - for shaping as required

Code	Description
SAFEDFLCIP30/50	(L) 56mm x (W) 20mm x (H) 8mm (folded) 5.7mm diameter pre-drilled hole in base
SAFEDFLCIP40/20	(L) 110.5mm x (W) 20mm x (H) 20mm (folded) 5.7mm diameter pre-drilled hole in base



Safe-D F-Clip 50 - Flex, Fit, Fold & Lock

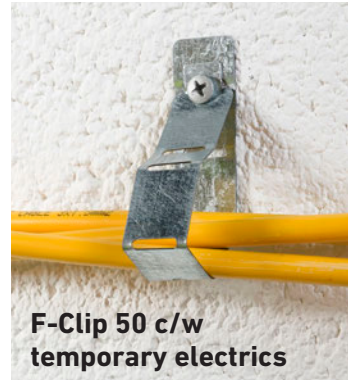
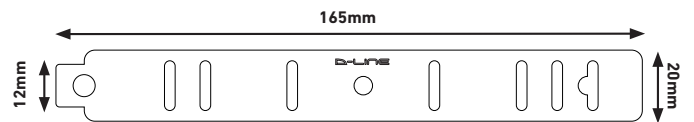

Safe-D F-Clip 50 is a fire-rated flexible cable clip that is supplied in flat form, and can be folded to make a variety of shapes to most effectively secure cable installations.

- Supplied flat...
 - Space efficient and pocket friendly
 - Easier handling - to save installation time
 - Easy folding to consider space and cable volume
 - Perfect for shot fired fixings
- >1200°C melting point
- Locking feature to hold cables most securely... simply push the tab through the preferred notch
- Locking tabs can be return-folded for a more secure installation
- 3x fixing holes for versatility
- Fit direct to surface, or in PVC trunkings
- Easy to later add or remove cable(s)
 - Can be opened/closed up to 5x
- Supplied in bags of 25 pcs



Code	Description
SAFEDFCLIP50/25	(L) 165mm x (W) 20mm x (H) 35mm (folded) 5.7mm diameter pre-drilled hole in base

Safe-D 20mm + 25mm Conduit Saddles

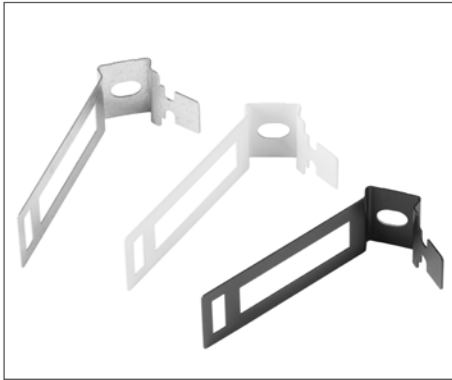
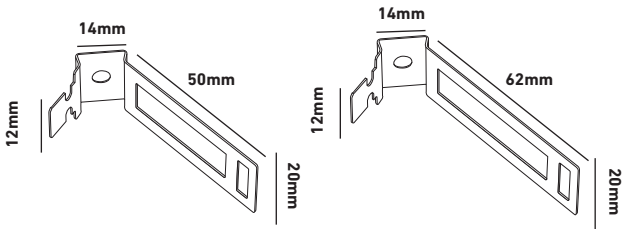

Provides a 3mm stand off from the surface



Simply wrap around the conduit, perfect for tight spaces

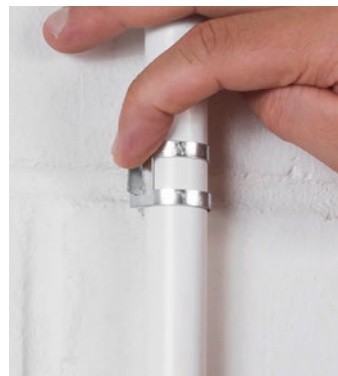

Secure conduit with locking tab

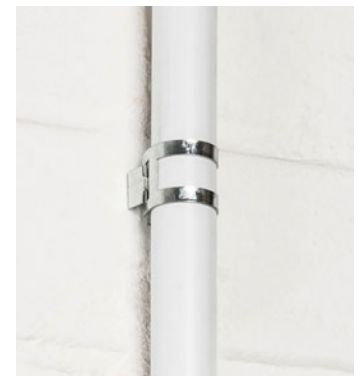

Centralised base fixing, gives a neat appearance to installation

Safe-D Conduit Saddles combine fire performance, quickest fix, and a modern look, to secure cables in 20mm & 25mm outer diameter PVC and galvanised conduit installations... & 20mm or 25mm o/d cables and pipes.

1 piece for only 1 fixing!

- Modern, stylish appearance
- Ideal for tight spaces
- Non-corrosive finish
- Unique single piece fixing, only 1x screw required - labour-saving design
- Fixing hole is ideal for use with D-Line D-Fixings
- Available in white, black or galvanised finish
- Adjustable slot in base for fixings
- Supplied in bags of 5 pcs

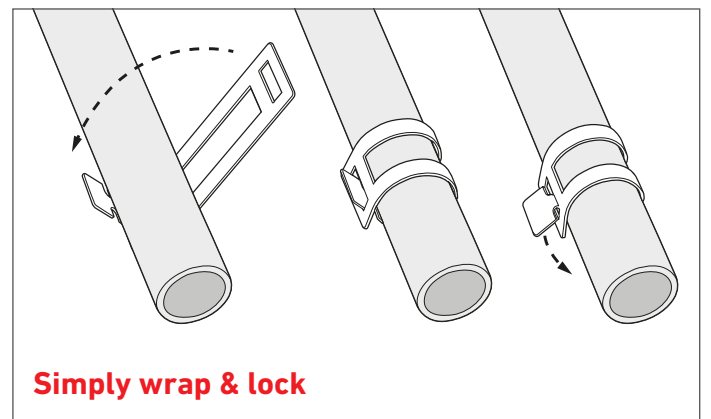

Simply wrap & lock

Code	Description	Colour
SAFE-DCOND20/5	(L) 86.19mm x (W) 20mm x (H) 23mm (folded)	Galv
SAFE-DCOND20W/5	(L) 86.19mm x (W) 20mm x (H) 23mm (folded)	White
SAFE-DCOND20B/5	(L) 86.19mm x (W) 20mm x (H) 23mm (folded)	Black
SAFE-DCOND25W/5	(L) 100mm x (W) 20mm x (H) 28mm (folded)	White
SAFE-DCOND25B/5	(L) 100mm x (W) 20mm x (H) 28mm (folded)	Black

Safe-D Stag Clips

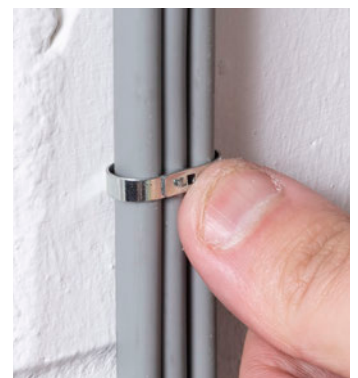
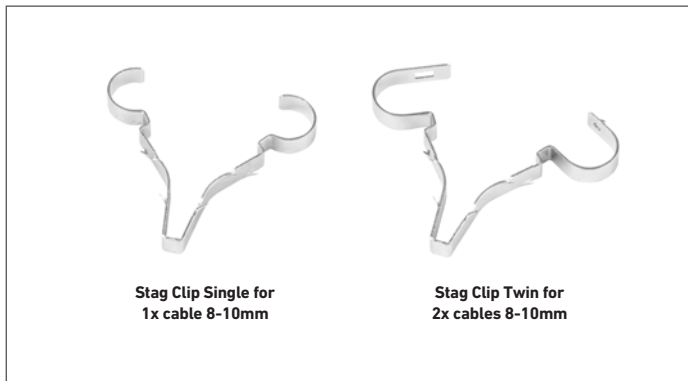

Drill pilot hole & select appropriate size of Stag Clip

Rest Stag Clip in the pilot hole ready to accept cable(s)

Insert cable(s) before squeezing the smooth head

Push home to secure the Stag Clip and cable(s)

Safe-D Stag Clips can be first-fixed with their lower barbs gripping in pilot-holes, ready for second-fix cabling works.

- >1200°C melting point
- Can be 1st fix rested in pilot hole, before 2nd fix inserting cable(s)
- No screw required, simply push smooth head in pilot hole, 5.5mm or 6mm x 30mm deep*
- Head sections overlap for secure cable fitment. 2x cable versions lock together when overlapped
- Ideal for FP & MICC cables, T&E and flexes
- Supplied in bags of 20 pcs

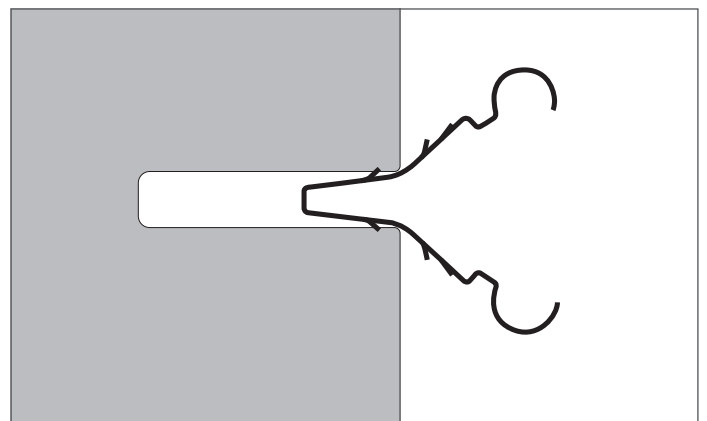

Code	Description	Colour
SAFEDSTAG8S/20	Holds 1x 8-10mm Cable	Galv
SAFEDSTAG8T/20	Holds 2x 8-10mm Cable	Galv



Safe-D T&E Grip Clips are user-friendly by a symmetrical design that makes it easy to hold the clip over T&E cable during installation... keeping finger and thumb away from hammer.

Grip Clips include flat-head nails with 2.5mm diameter shafts that enable effective knock-in to mortar and wood; compared to alternative designs with thinner nails, the 2.5mm shaft minimises the risk of a nail bending or buckling in hard substrates.

- Produced from steel, fire-rated to 1200C+
- Flat-head nail sits tight when knocked-in
- 2.5mm diameter nail body, suitable for harder substrates
- User-friendly design for easy positioning - keeping finger & thumb away from hammer
- 3x sizes for popular T&E clips (1.5, 2.5, & 6.0mm)²
- Raised strip on clip-head prevents cable bruising if mis-hit!
- All nails have 2.5mm body dia, 5.5mm head dia & 25mm length
- Supplied in bags of 20 pcs



Code	Description
SD-TE1.5/20	Holds 1x 1.5mm T&E cable
SD-TE2.5/20	Holds 1x 2.5mm T&E cable
SD-TE6.0/20	Holds 1x 6.0mm T&E cable

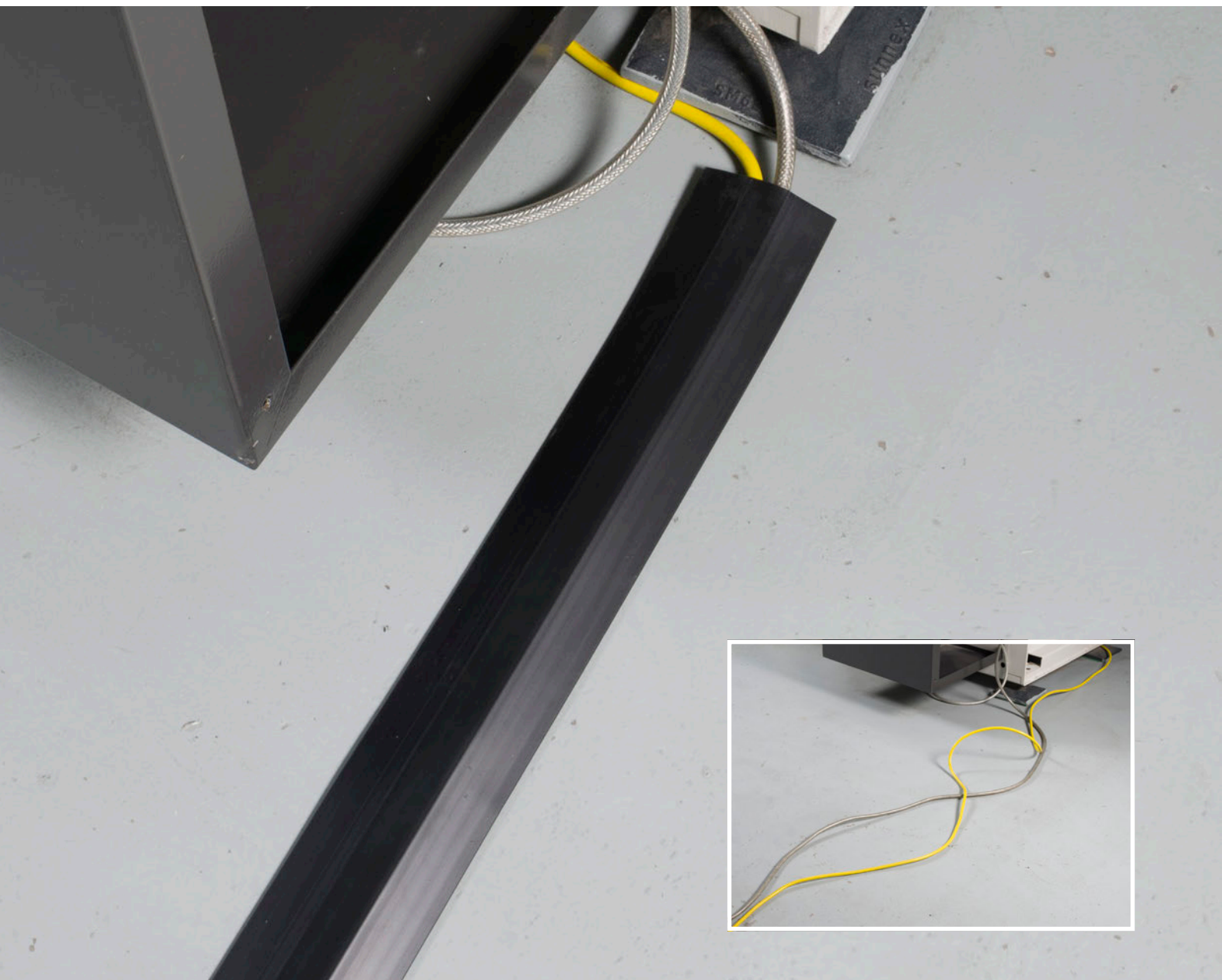

In recent years it is a fact that personal work spaces and living spaces have both reduced, while at the same time the volume of cables around us, and often under our feet, has increased. The impact of both trends make cable management a critical issue, which requires a pro-active and responsible approach.

D-Line cable safety ranges address common dangers from 'cable mis-management', with affordable & unique solutions that can simply retro-fit around existing cables.

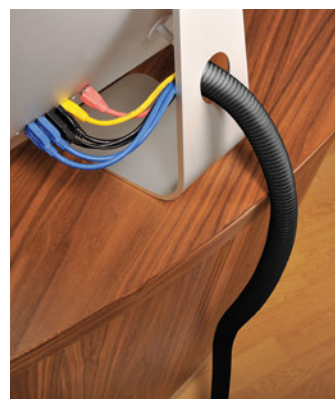
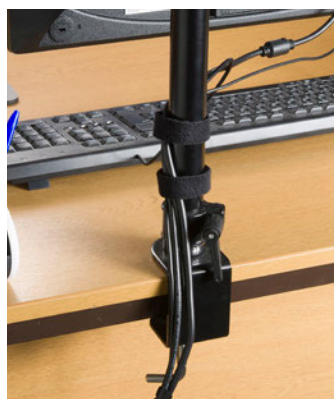



Medium Duty Floor Cable Protectors

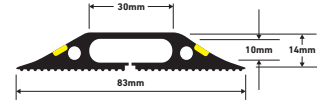
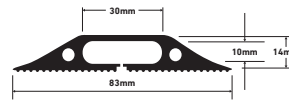
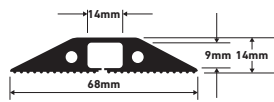
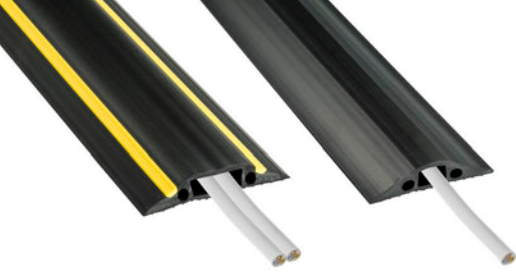

Medium Duty profiles uncoil to effectively lay flat across surfaces, while the tapered sloping sides are pedestrian-friendly.

The connector pins provide an effective friction-fit connection that can be pushed-in, then later pulled apart, in adjoining lengths – to cover whatever length of cable is required.

- Pre-split back retro-fits over cables
- 4mm x 9mm or 30mm x 10mm cavity options
- Ribbed non-slip base, pre-split rear for ease of use
- Flexible PVC - Neat tapered design, lengths uncoil to lay flat

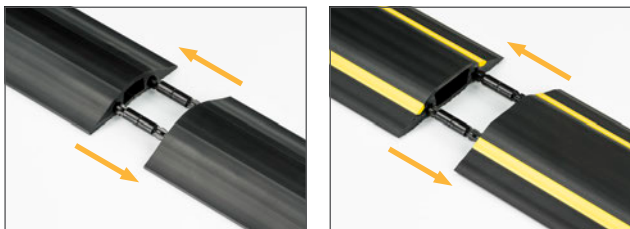

Linkable - Lengths supplied with 2 connector pins

Code	Description	Colour
FC68B/9M	(L) 9.0m x (W) 68mm x (H) 14mm - Inner channel - (W) 14mm x (H) 9mm	Black
FC83B	(L) 1.8m x (W) 83mm x (H) 14mm - Inner channel - (W) 30mm x (H) 10mm	Black
FC83B/9M	(L) 9.0m x (W) 83mm x (H) 14mm - Inner channel - (W) 30mm x (H) 10mm	Black
FC83H	(L) 1.8m x (H) 83mm x (H) 14mm - Inner channel - (W) 30mm x (H) 10mm	Black/Yellow
FC83B/9M	(L) 9.0m x (H) 83mm x (H) 14mm - Inner channel - (W) 30mm x (H) 10mm	Black/Yellow

Cable Zipper

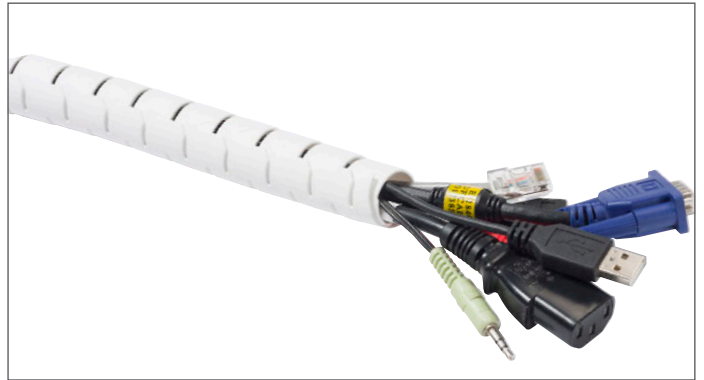
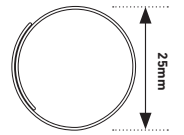

Simply place the cables in the zip tool, then pull the zip tool down along the length of the Zipper.

The cables then transfer from the tool into the length of Zipper, to provide an incredibly quick and easy way to neatly organise several cables.

The cut-outs along the length enable the Zipper to bend in tight radii.

- Ideal to conceal & protect longer runs of cables
- Quick and easy to use - scissor cut to length; insert cables in zip tool; put zip tool in to length; pull zip tool along length
- Flexible design and good resistance to oils/lubricants, acids & alkalis - suitable for use around plant and machinery too
- Zip tool included in pack
- Operating temperature -30°C to +85°C



Code	Description	Colour
CZ252.5W	(L) 2.5m - 25mm diameter	White
CZ252.5B	(L) 2.5m - 25mm diameter	Black

Socket Enclosures

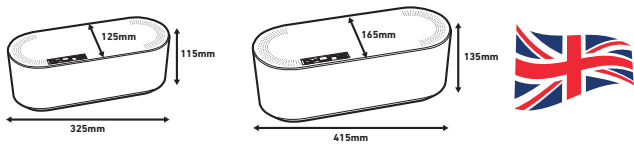

D-Line Socket Enclosures (aka Cable Tidy Units) provide the most popular solution to contain extension sockets and cable spaghetti. The smart tech design blends with modern surroundings. 3x rear cable entry/exit slots enable cables to be routed to left-side, right-side or vertical.

Fully safety tested, and produced from electrically-safe robust ABS material with an effective click-lock lid, these Socket Enclosures sort unsightly cables and contribute to a positive Health & Safety culture.

- Tidy, route & sort unsightly cable clutter
- Make surfaces easier to clean
- Make socket blocks less accessible
- Prevent feet snagging cables under desks - save entanglements and costly disconnections
- Produced using electrically-safe ABS material

Code	Description	Colour
EU/CTUSMLB/SW	(L) 325mm x (W) 125mm x (H) 115mm	Black
EU/CTUSMLW/SW	(L) 325mm x (W) 125mm x (H) 115mm	White
EU/CTULGEB/SW	(L) 415mm x (W) 165mm x (H) 135mm	Black
EU/CTULGEW/SW	(L) 415mm x (W) 165mm x (H) 135mm	White

Split Cable Tube

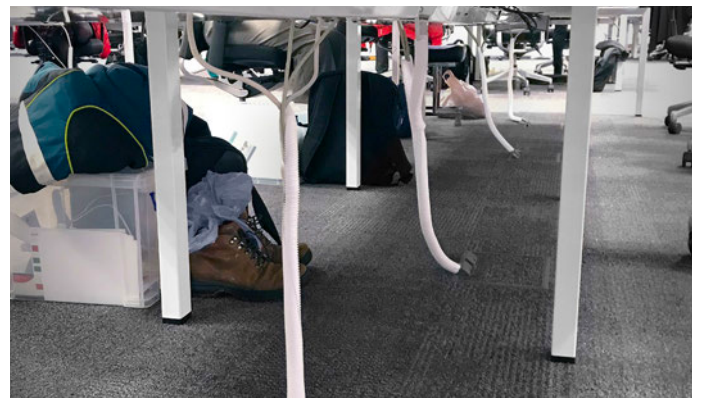
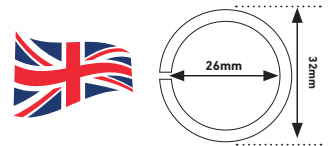

Cables can be manually inserted into Split Cable Tube to offer a neat way of organising a cluster of cables.

The 1.1m (3ft 7") length is ideal to sort cables dropping behind desks and TVs.

The LDPE material is very user-friendly to handle, and makes it easy to later add or remove cables.

- Tidy & protect several cables
- Ideal to contain cables dropping behind TVs and desks
- Pre-split - fits around existing cables
- Flexible & easiest to add or remove cables
- Fully safety tested and certified to EN 60695-2-11: 2014

Code	Description	Colour
CTT1.1B	(L) 1.1m - 32mm diameter	Black
CTT1.1W	(L) 1.1m - 32mm diameter	White

Cable Spiral Wrap

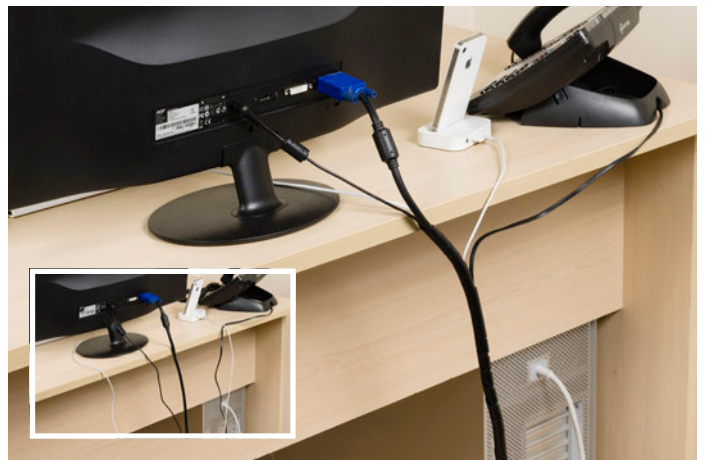
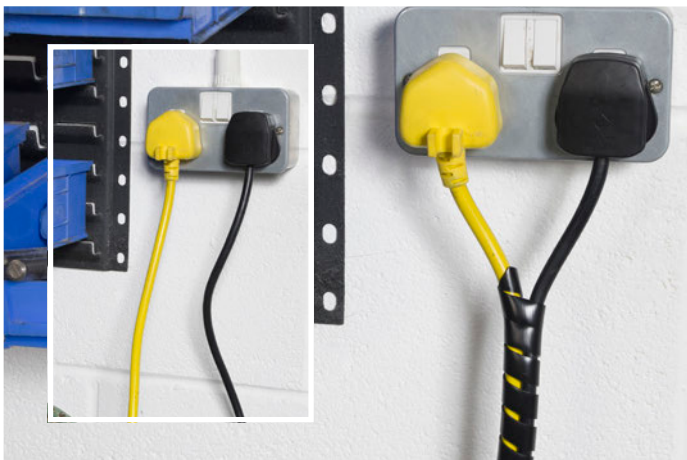
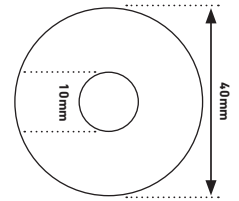

Cable Spiral Wrap can expand to contain bundles of cables up to 40mm diameter.

Users simply wrap the Spiral around cables to give effective protection to cables.

This versatile solution allows cables to enter or exit along the length, so making a popular option for use in tight spaces.

- Versatile, easy to exit cables at any point along length
- Ideal for shorter runs of cable
- 1.5mm gauge LDPE material protects cable insulation

- Expands around bundles of cables up to 40mm diameter
- Good resistance to oils/lubricants, acids & alkalis
- Easy to cut to required length, then wrap by hand
- Fully safety tested and certified to EN 60695-2-11: 2014

Code	Description	Colour
CTW2.5B	(L) 2.5m - 10mm - 40mm diameter	Black
CTW2.5W	(L) 2.5m - 10mm - 40mm diameter	White

Cable Band



While commonly used as a reusable cable tie to secure cables to supports, this versatile hook & loop Band is ideal for multi-purpose applications.

Fully safety-tested, Cable Tidy Band can hold up to 10kg when fastened with 50mm overlap.

- Tested to hold up to 10kg with a 50mm overlap
- Hook & loop design
- Scissor cut as required; Re-usable
- Versatile 1.2m length



Code	Description	Colour
CTTAPE20001	(L) 1.2m x (W) 20mm	Black



D-Line (Europe) Limited

Alder Road, North Shields, NE29 8SD UK

Tel: +44 (0)191 236 0960 **Email:** trade@d-line-it.com **Web:** www.d-line.com



D-Line Trade



dlinetrade



D-Line (Trade)



Stefani Australasia Pty Ltd

80 Pilbara Street, Welshpool, WA, 6106

Phone: +61 8 9350 6178 **Fax:** +61 8 9350 5988